

*Vue de face*

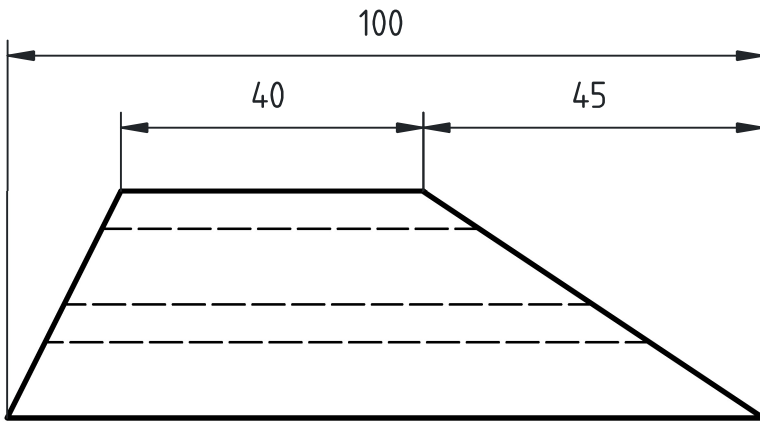

*Vue de gauche*

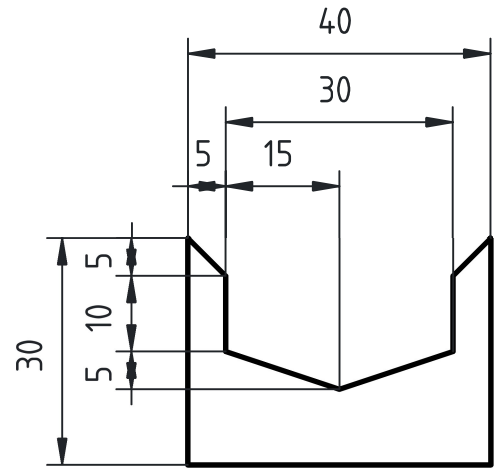

*Vue de dessus*

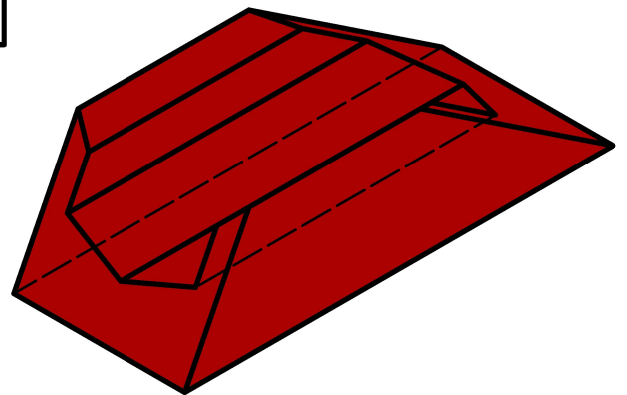
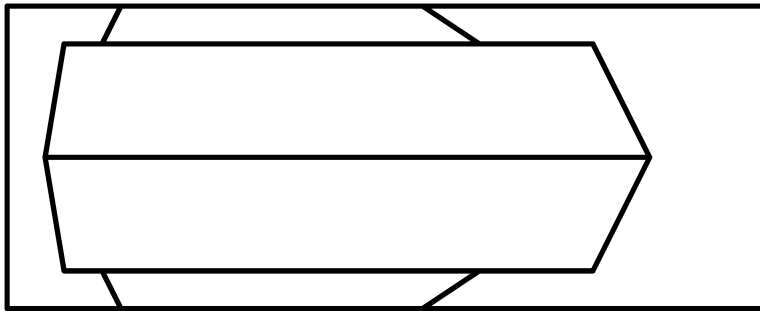

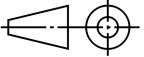
1	Bloc prismatique	A.50	100 x 40 x 30	1	Masse : 0.413 Kg
Rep.	Désignation	Matière	Dimensions	Nbr.	Observations
Conçu par Wills	Vérfié par Wills	Approuvé par H.B	 Date 04-04-2026	Ech : 1/1	
<b>By Wills Conception</b>		Titre : Bloc prismatique			
		Modification		Feuille 1/1	